



STEADMANS
ROOFING & CLADDING

Purlins, Rails, Eaves Beams & Mezzanine Flooring Beams

Steadmans are one of the UK's leading manufacturers of roofing and cladding, supplying high quality materials throughout the United Kingdom of Great Britain and Ireland.

We offer roofing and cladding solutions for your project in a wide range of insulated panels, single and twin skin systems and secondary steelwork including purlins, rails and eaves beams.

Our continuous investment programme and on-going product development ensures we can provide high quality products promptly and at competitive prices.

Professional designers and contractors, as well as non-professional builders, benefit from our comprehensive technical support including technical brochures, data sheets and CAD details.



We have a full range of purlins, rails, eaves beams and mezzanine flooring beams available, plus all of the necessary fixings and accessories.

Our Zed section and Cee section range covers 140, 170, 200, 240 & 300mm deep sections which are available in a range of thicknesses.

We have two Eaves beam designs:

- Indented eaves beams - 200 & 240mm
- Flat backed eaves beam - 300mm

Steadmans realise that our standard range will not meet all requirements and therefore customer designed sections can be manufactured along with individual designs for special applications.

A separate brochure containing load tables for the Purlins, Rails & Eaves Beams is also available from Steadmans upon request.



Roof Cladding

Wall Cladding

Brickwork

STEADMANS is the complete one-stop-shop for metal roofing and cladding.

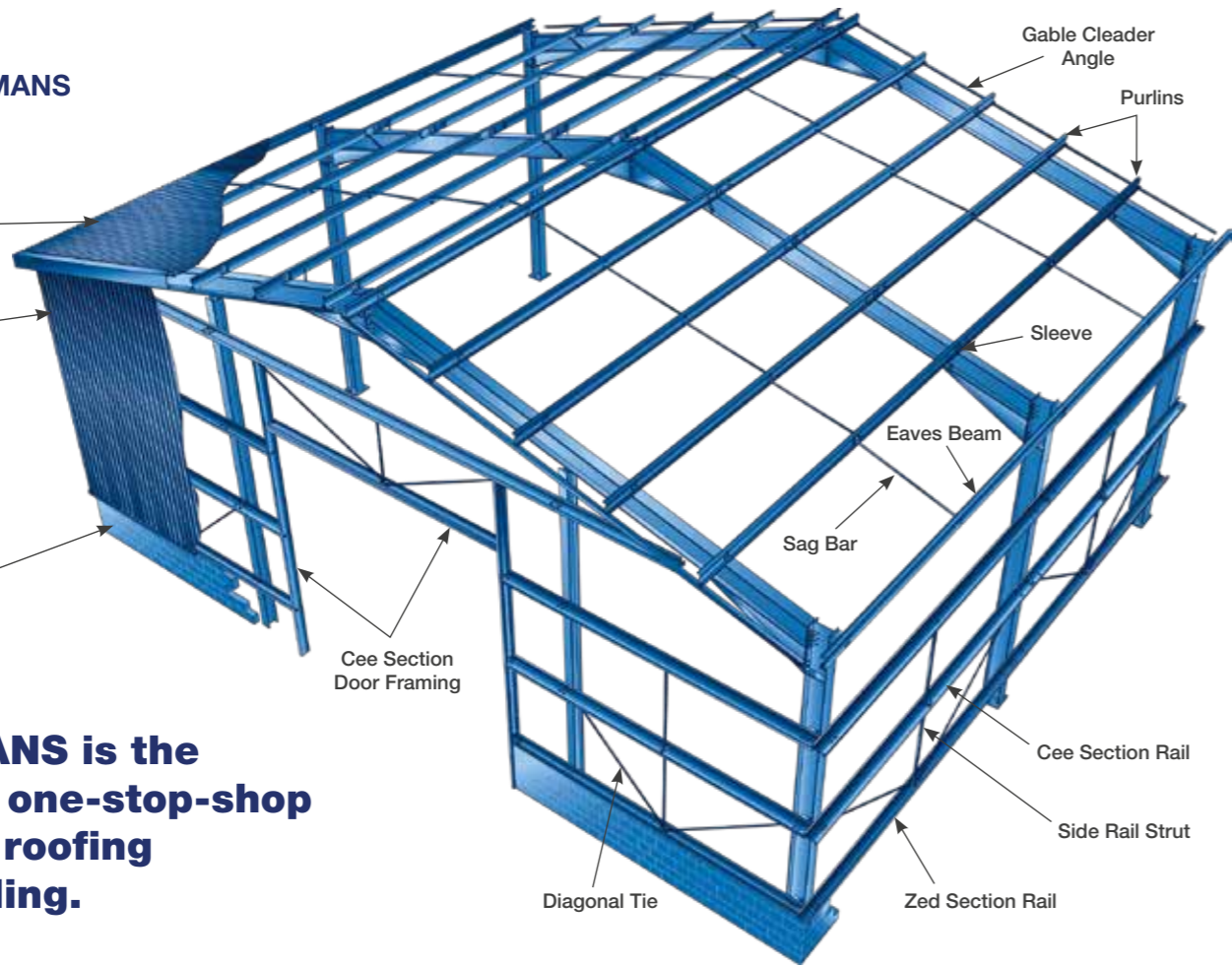

Zed Sections

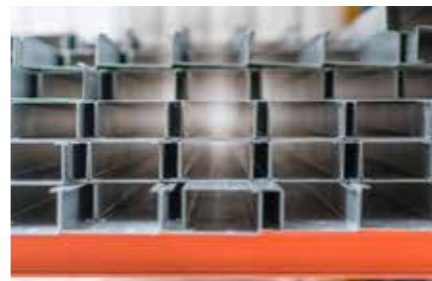

Cee Sections



Eaves Beams

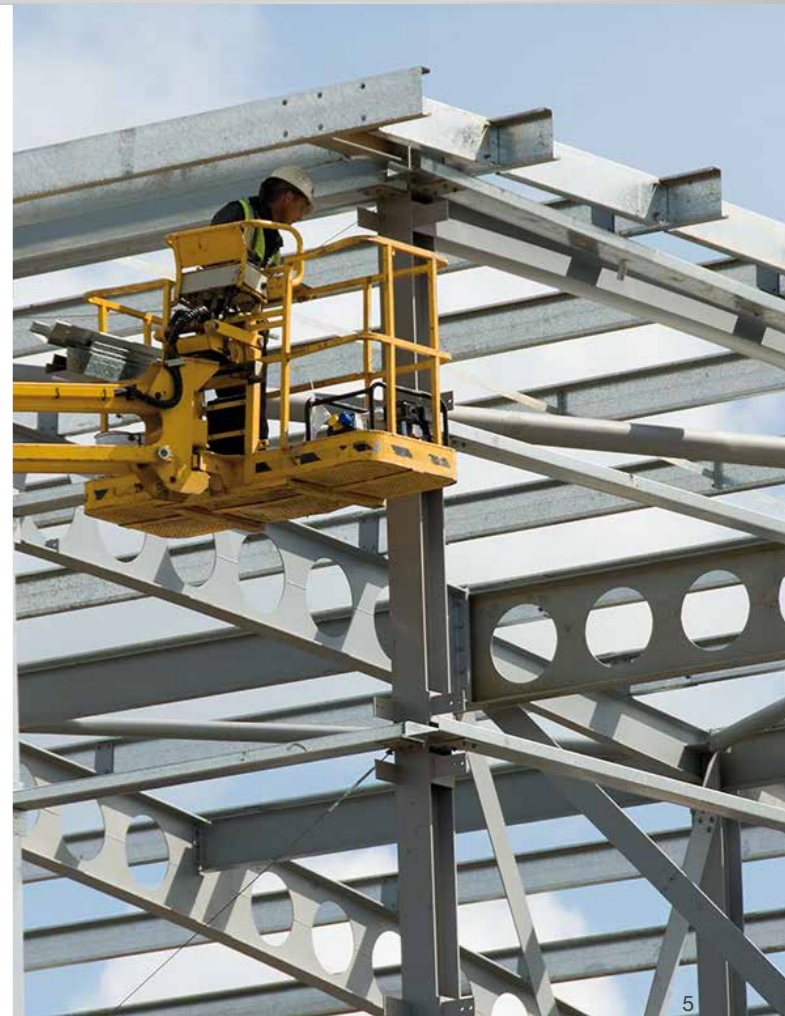

Roof Zed Purlin systems allow for a flexible efficient range of solutions to roofing supports for a wide variety of cladding types. Three structural systems are available, all of which allow for a flexible and efficient range of solutions to roofing supports for a wide variety of cladding types

We offer three structural systems:

- Sleeved
- Double-Span Sleeved
- Butted

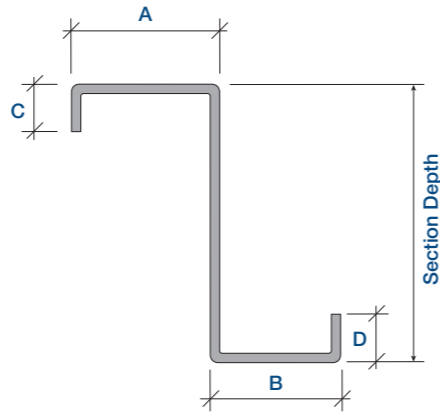

Section Depth	Zed's			
	A	B	C	D
140, 170	60	54	16	20
200	70	64	16	20
240	75	67	18	22
300	95	87	21	25

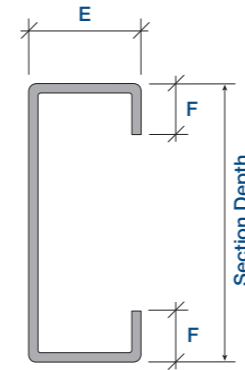
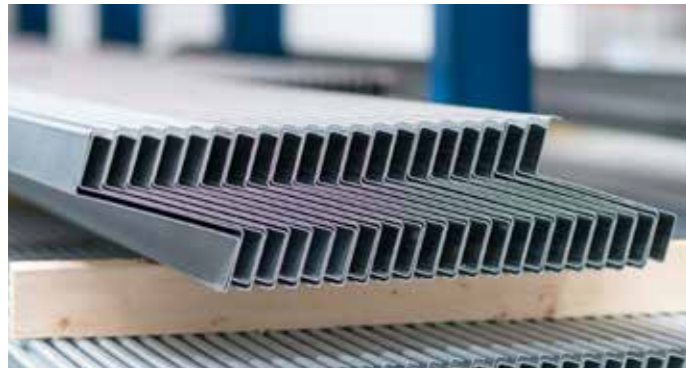

Section Depth	Cee's	
	E	F
140, 170	62	13
200	70	15
240	74	17
300	95	19

Sheeting rails may be selected as either Zed or Cee profile sections. Formed from the same coils, they are each available in the same depth and thickness range. Cees may be substituted for Zeds at window and door framing and at composite cladding joints, etc.



Three depths of eaves beams are available. Sections are available in 200mm and 240mm depth. A 300mm deep flat back eaves beam is available. Eaves beams are usually single spanning but the 200 and 240 series may be supplied as double-spanning up to a 5m span and the 300 series can be double-spanning up to a 7.5m span.

Zed, Cee and Eaves Beam sections are manufactured under managements system certified to ISO 9001:2015.

These sections are designed to BS EN 1993-1-3:2006 using a combination of rational analysis and component testing.

The products are manufactured from pre-galvanised S450 grade steel, with a minimum yield strength of 450N/mm².

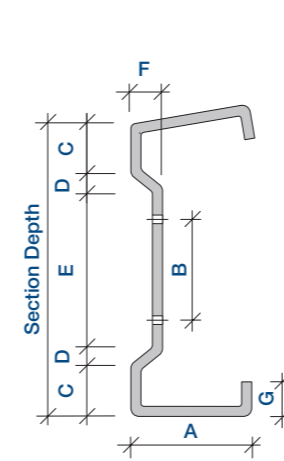

200 Eaves Beam Series

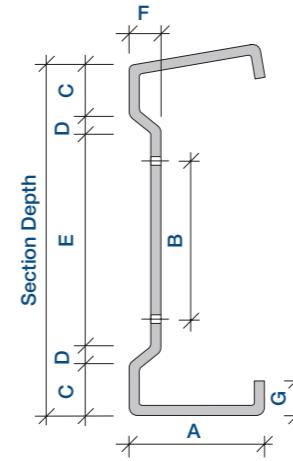

240 Eaves Beam Series

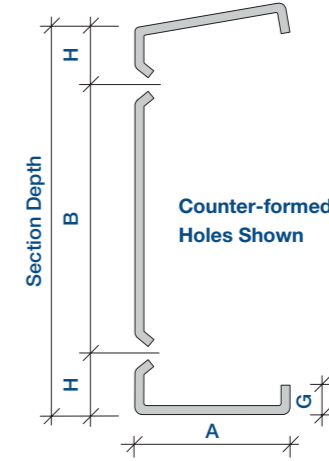

300 Eaves Beam Series

Section Depth	Eaves Beams							
	A	B	C	D	E	F	G	H
200	15	70	30	15	110	15	20	-
240	90	110	30	15	150	15	20	-
300	95	218	-	-	-	-	19	41

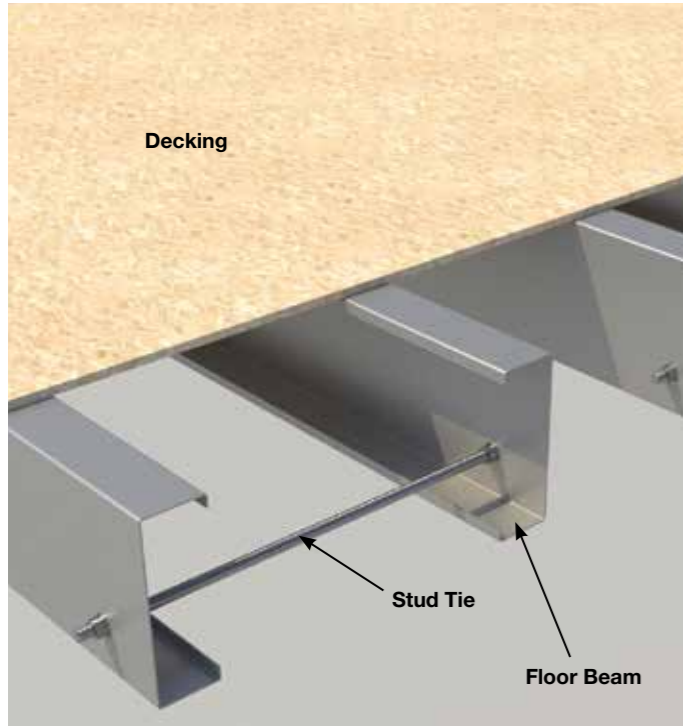

Steadmans MC floor beams are Cee-sections manufactured from pre-galvanised S450 grade steel, with a minimum yield strength of 450N/mm².

The sections are designed to BS EN 1993-1-3:2006 using a combination of rational analysis and component testing. Mezzanine Sections are manufactured under a management system certified as meeting the requirements of ISO 9001:2015, which covers all aspects of our operations.

We have a full range of accessories to complement our mezzanine beams, including web and over-sail cleats and stud ties, along with design assistance and electronic detailing sheets.

For further details please contact us on:

01697 478 277

info@steadmans.co.uk

or visit

www.steadmans.co.uk

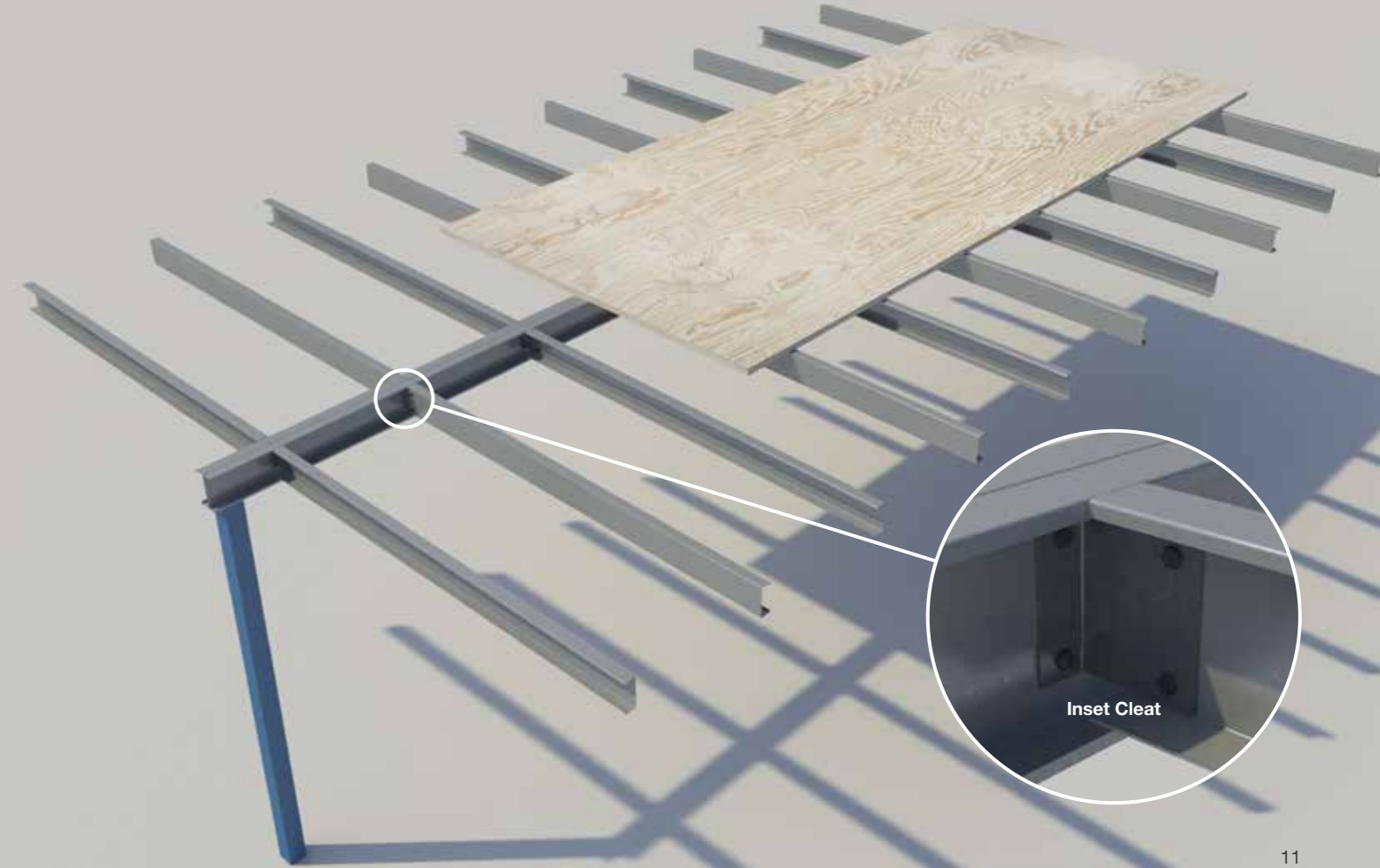



STEADMANS

ROOFING & CLADDING



England & Wales

Warnell,
Welton,
Carlisle,
Cumbria
CA5 7HH

T) 01697 478277

F) 01697 478530

Scotland & Ireland

Unit C,
Coalburn Road,
Bothwell,
Glasgow
G71 8DA

T) 01698 819 050

F) 01698 801 764

Northern Scotland

Mill of Crichtie
Fyvie,
Turriff,
Aberdeenshire
AB53 8QL

T) 01651 891 668

F) 01651 891 698

©Building Solutions (National) Ltd.

The information given in this guide shall be regarded as accurate at the time of going to print and may be subject to change thereafter. Building Solutions (National) Limited reserves the right to alter or delete any product and/or technical specification featured in this guide without prior notice.

Issue 1 - 03/2023 / SK

www.steadmans.co.uk • info@steadmans.co.uk

A Steadman & Son is a trading division of
Building Solutions (National) Ltd

